

## CPF 50-12

Front access AGM battery (10-12 year design life)

Dimensions (mm)

Standard terminal

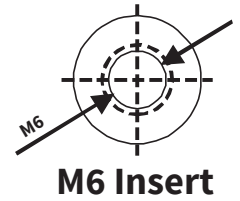
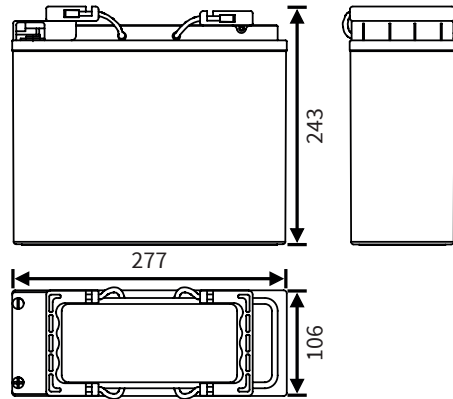

No image available at this time

### Typical applications

- UPS systems
- Data centers
- Telecom systems
- 19" Applications
- Security systems
- Emergency lighting
- Evacuation systems
- Medical equipment

### Features

- Valve Regulated Lead Acid (VRLA)
- Maintenance free
- Absorbent Glassmat Technology (AGM)
- Low self discharge
- Classified as non-spillable under IATA, ADR and IMDG regulations
- Can be discharged or stored in any position without leakage
- Battery cannot be charged while upside down
- Produced under ISO 9001 & ISO 14001

Nominal voltage	12 V
Nominal capacity (1.70V/c, 20°C)	10Hr: 50.2 Ah
	5Hr: 45.7 Ah
	1Hr: 33.8 Ah
Internal resistance	≤8.0mΩ (fully charged)
Maximum charge current	15 A
Maximum discharge current	500 A (max. 5 sec)
Float use / cyclic use	13.4 - 13.6V / 13.8 - 14.1V
Operational temperature range	-20°C ~ 60°C
Designlife (25°C)	10-12 years in float (Eurobat)
Standard terminal	M6 Insert (8.5 Nm torque)
Housing material	ABS (UL 94-V0)
Dimensions Length	277 mm
Dimensions Width	106 mm
Dimensions Height	243 mm
Approximate Weight	17.3 kg
Packing	1 pcs / box

### Constant Current Discharge (Amps) at 20°C (77°F)

F.V/TIME	10 Min	15 Min	30 Min	45 Min	60 Min	3 Hr	5 Hr	10 Hr
1.80V/cell	77,0	66,0	49,0	38,8	32,4	13,6	9,00	5,00
1.75V/cell	85,0	71,6	51,2	40,1	33,1	13,8	9,06	5,01
1.70V/cell	93,0	77,1	53,3	41,4	33,8	14,1	9,13	5,02
1.65V/cell	101,0	82,7	55,5	42,7	34,5	14,3	9,19	5,03
1.60V/cell	109,0	88,2	57,6	44,0	35,2	14,5	9,26	5,04

### Constant Power Discharge (Watts) per Cell\* at 20°C (77°F)

F.V/TIME	10 Min	15 Min	30 Min	45 Min	60 Min	2 Hr	3 Hr	5 Hr
1.80V/cell	147,00	127,00	93,40	74,10	61,70	37,00	27,00	17,90
1.75V/cell	158,00	135,00	97,90	76,90	63,50	37,50	27,40	18,10
1.70V/cell	168,00	143,00	102,00	79,80	65,30	37,90	27,90	18,20
1.65V/cell	179,00	151,00	107,00	82,70	67,10	38,40	28,20	18,40
1.60V/cell	190,00	159,00	111,00	85,60	69,00	38,90	28,50	18,50

\*: Battery consists of 6 cells

## Charge characteristics

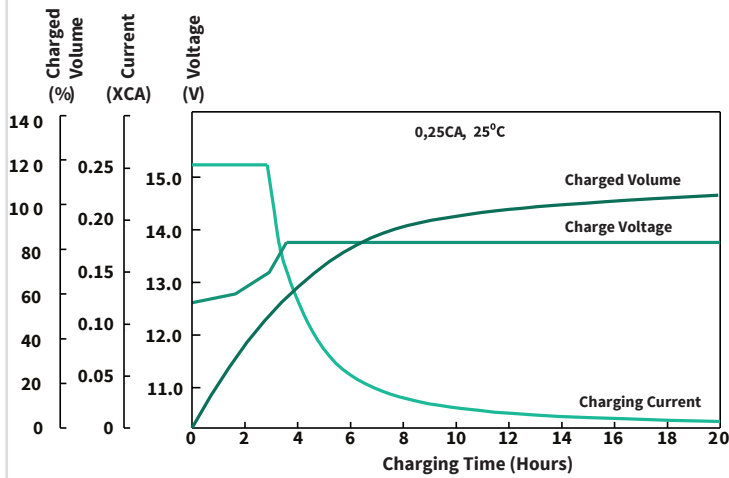

## Discharge characteristics

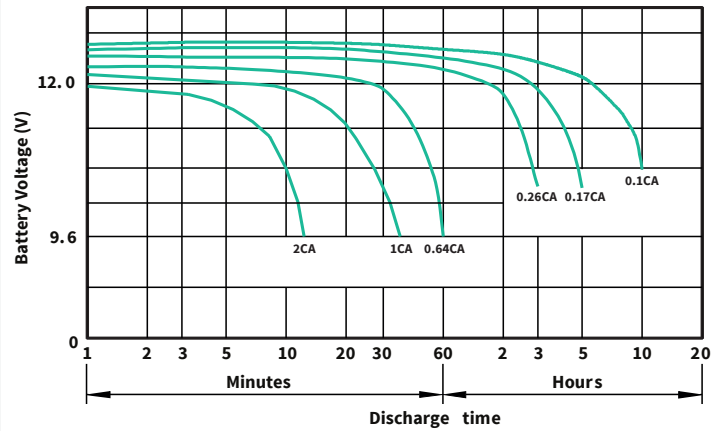

## Service life in relation to temperature

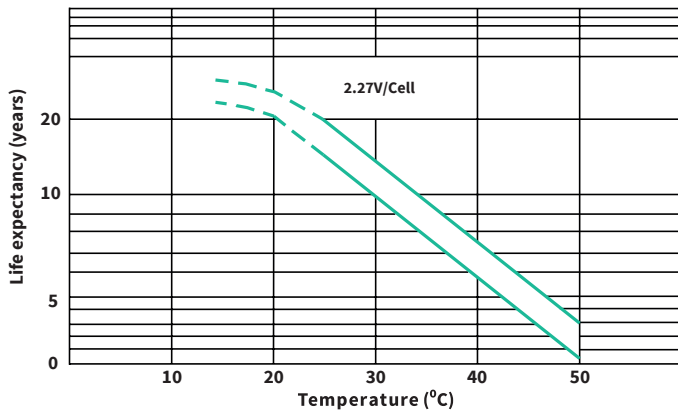

## Capacity in relation to temperature

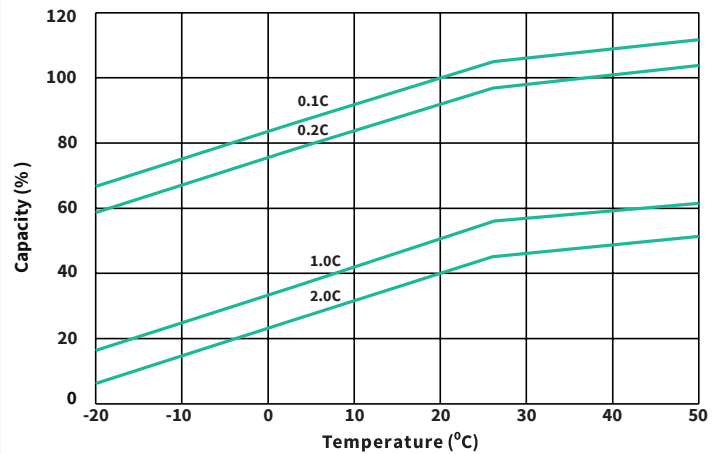

## Models available

Model	Voltage	Capacity (Ah)	Dimensions (mm)	Weight (kg)
CPF 50-12	12	50	277x106x243	17.3
CPF 100-12HT	12	100	506x110x227	32.5
CPF 105-12	12	105	395x110x293	35.0
CPF 140-12	12	140	552x110x295	49.0
CPF 180-12	12	180	546x125x323	58.5

## Recommended

Having the right battery is often just the beginning. Optimal use of a battery requires having a good battery charger, so that the user can be sure that their battery is always optimally charged and has maximum lifespan. Cellpower offers various intelligent battery chargers, as well as battery testers, battery monitors and battery guards. All designed to easily monitor the battery quality and make sure the battery remains in the best condition possible.

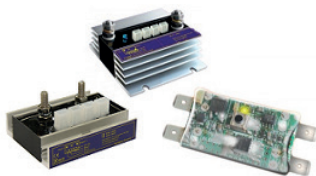

## Cellpower family

Cellpower supplies a broad range of reliable AGM, GEL and Lithium batteries. Each product series has its own unique characteristics, so that there is a suitable battery for every application with its associated specific usage profile. Combined with the right Cellpower battery accessories, you are able to assemble a high-quality and reliable battery system.

The sealed, maintenance-free AGM lead battery type has a long operational lifetime. When used correctly, the Absorbed Glass Mat (AGM) technology offers dependable, lasting service. Additionally, AGM batteries exhibit very little self-discharge when compared with other lead-acid batteries. Sealed lead-acid batteries require low maintenance and do not need to be refilled with water or other liquids.

