

## CPS 600-2

## Single cell battery (20 year design life)

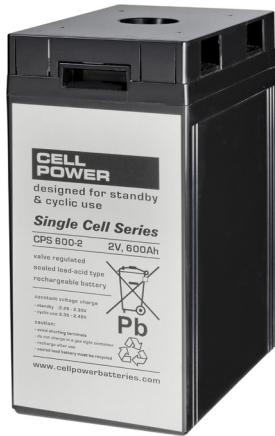

### Dimensions (mm)

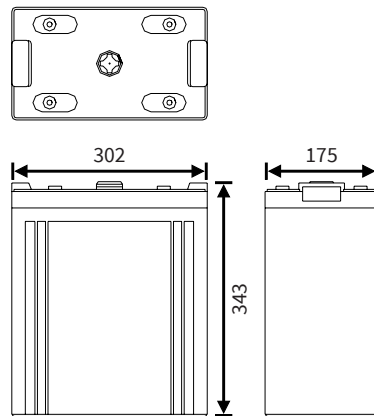

### Standard terminal

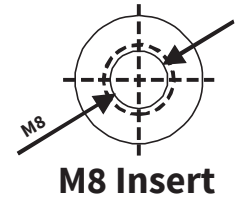

### Typical applications

- Marine
- UPS systems
- Data centers
- Telecom systems
- Security systems
- Air traffic power stations
- Medical equipment
- Solar energy
- Military bases

### Features

- Valve Regulated Lead Acid (VRLA)
- Absorbent Glass Mat Technology (AGM)
- Maintenance free
- Low self-discharge rate
- Classified as non-spillable and Non Dangerous goods by IATA, FAA, ADR, IMDG
- Can be discharged or stored in any position without leakage
- Battery cannot be charged while upside down
- Produced under ISO 9001 & ISO 14001

Nominal voltage	2 V
Nominal capacity (1.75V/c, 25°C)	10Hr: 610.0 Ah
	5Hr: 540.0 Ah
	1Hr: 322.0 Ah
Internal resistance	≤0.60mΩ (fully charged)
Maximum charge current	120 A
Maximum discharge current	3000 A (max. 5 sec)
Float use / cyclic use	2.20 - 2.30V / 2.40 - 2.45V
Self discharge	Lower than 3% per month
Operating temperature range	-20°C ~ 60°C
Designlife (20°C)	20 years in float
Standard terminal	Insert M8 (12.4 Nm torque)
Housing material	Flame retardant ABS (UL94-V0)
Dimensions Length	302 mm
Dimensions Width	175 mm
Dimensions Height	343 mm (367 mm with cover)
Approximate Weight	40.0 kg
Packing	1 pcs / box

### Constant Current Discharge (Amps) at 25 °C (77°F)

FV/TIME	15 Min	30 Min	45 Min	60 Min	3 Hr	5 Hr	10 Hr
1.80V/cell	710	503	397	307	160	105	60
1.75V/cell	755	533	419	322	167	108	61
1.70V/cell	800	562	440	337	174	111	63
1.65V/cell	844	590	461	351	181	113	64
1.60V/cell	887	618	480	364	186	115	65

### Constant Power Discharge (Watts) per Cell\* at 25 °C (77°F)

FV/TIME	15 Min	30 Min	45 Min	60 Min	2 Hr	3 Hr	5 Hr
1.80V/cell	1112	892	731	583	418	309	211
1.75V/cell	1191	951	776	617	446	330	214
1.70V/cell	1269	1009	820	649	460	340	218
1.65V/cell	1347	1067	864	680	472	349	222
1.60V/cell	1424	1123	905	710	483	358	225

\*: Battery consists of 1 cell

### Recommended

Having the right battery is often just the beginning. Optimal use of a battery requires having a good battery charger, so that the user can be sure that their battery is always optimally charged and has maximum lifespan. Cellpower offers various intelligent battery chargers, as well as battery testers, battery monitors, battery guards and galvanic isolators. All designed to easily monitor the battery quality and make sure the battery remains in the best condition possible.



## Charge characteristics

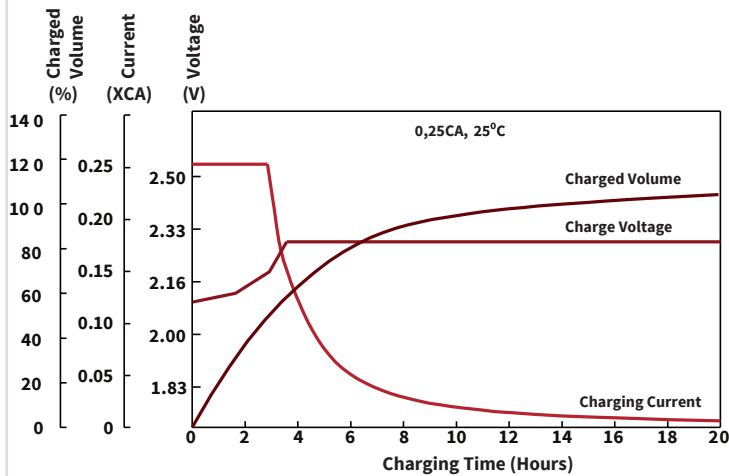

## Discharge characteristics

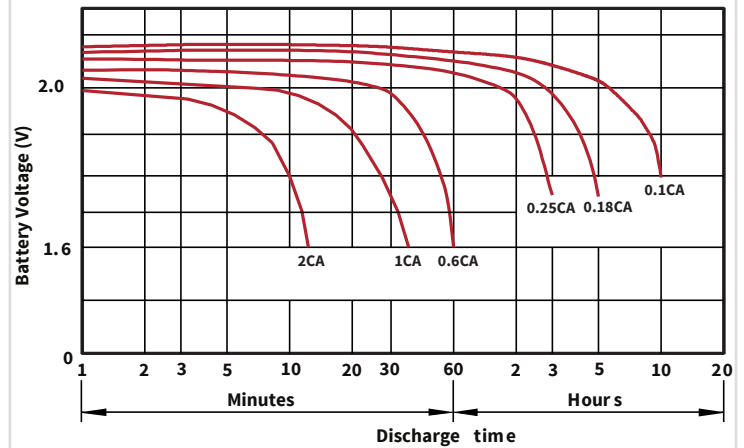

## Relationship between servicelife and temperature

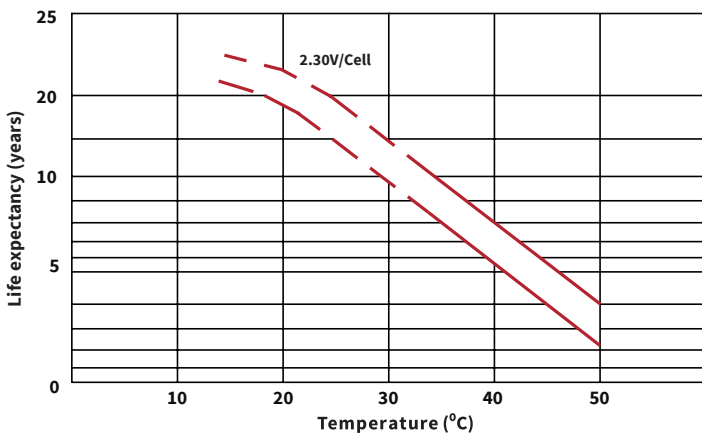

## Cycle service life in relation to depth of discharge

Testing conditions: Discharge current 0.17CA (FV 1.70V/cell)  
Ambient Temperature: 25°C (77F)

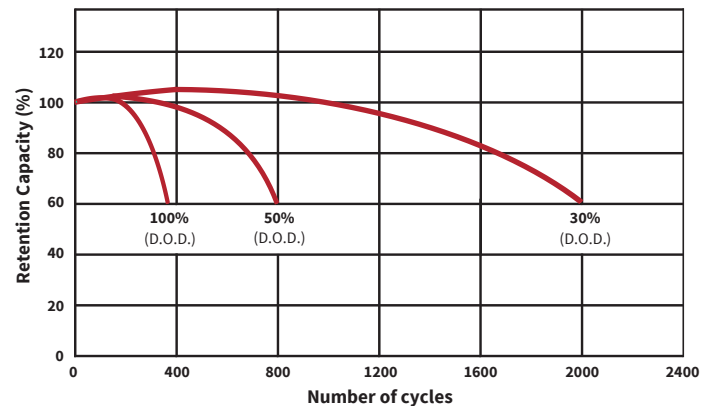

## Models available

Model	Voltage	Capacity (Ah)	Dimensions (mm)	Weight (kg)
CPS 200-2	2	200	173x111x329/364	14.2
CPS 300-2	2	300	171x151x330/364	20.0
CPS 400-2	2	400	211x176x329/367	28.0
CPS 500-2	2	500	241x173x330/365	33.0
CPS 600-2	2	600	302x175x331/367	40.0
CPS 1000-2	2	1000	475x175x340/367	66.5
CPS 1500-2	2	1500	400x350x367/382	100.0
CPS 2000-2	2	2000	490x350x367/382	132.0
CPS 3000-2	2	3000	710x350x367/382	210.0

## Cellpower family

Cellpower supplies a broad range of reliable AGM, GEL and Lithium batteries. Each product series has its own unique characteristics, so that there is a suitable battery for every application with its associated specific usage profile. Combined with the right Cellpower battery accessories, you're able to assemble a high-quality and reliable battery system.

The sealed, maintenance-free AGM lead battery type has a long operational lifetime. When used correctly, the Absorbent Glass Mat (AGM) technology offers dependable, lasting service. Additionally, AGM batteries exhibit very little self-discharge when compared with other lead-acid batteries. Sealed lead-acid batteries require low maintenance and do not need to be refilled with water or other liquids.

