



Powersine Combi

combined inverter, battery charger and AC transfer switch

Description | The PSC2000-12-80 and PSC2500-24-50 Powersine Combi products are based on the latest generation Powersine inverter engine, which guarantees very reliable operation and huge output power reserves. The Powersine Combi also features a powerful intelligent battery charger and an ultra fast AC transfer switch. All this is combined in a very compact, yet installer friendly unit.

The Powersine Combi offers many innovative features like AC Input Power Boost, which temporarily assists weak AC input sources when more power is needed than available. Another feature is AC Input Current Limit, which limits the maximum current consumed from the AC input source by the Powersine Combi in charger mode.

Furthermore, the Powersine Combi is equipped with a TBSLink port to connect to a remote control or to a Windows device running TBS Dashboard, for easy step by step configuration and readout.

Also available are two fully configurable 16A alarm relay outputs and two unique trigger inputs, that can convert external trigger commands into a number of Powersine Combi status changes.

Each Powersine Combi comes standard with a mounting kit, a temperature sensor, crimp terminals for DC cables and clear manuals.

Features

- True sinewave AC output
- Robust industrial design
- High surge power output
- Powerful 4-stage two output battery charger
- Power factor corrected AC input
- Fast 30A AC transfer switch
- AC Input Power Boost
- AC Input Current Limit
- Protected against high/low battery voltage, high temperature, overload, short circuit, high ripple voltage and low AC input voltage
- Automatic Standby function to reduce no-load power consumption
- Variable speed fan for silent operation
- Remote on/off capability
- Two programmable 250V/16A relays
- Two trigger inputs
- Remote control capability via TBSLink
- Easy to access connection bay for installing AC-, DC and control wiring
- CE certified
- 24 month warranty

Applications

- Recreational vehicles
- Marine applications
- Solar power systems
- Industrial systems
- Mobile entertainment systems
- Service vehicles
- Remote homes

Accessories

- Universal Remote Control with LCD¹⁾
- Basic Remote Control with LEDs
- DC cable kits
- TBSLink communication kit including software
- Alarm output expander

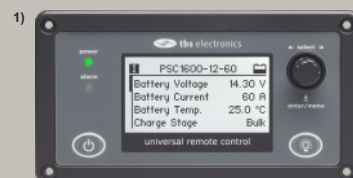

Technical specifications

Parameter		PSC2000-12-80 (art. no. 5018100)	PSC2500-24-50 (art. no. 5018120)
Inverter stage			
Output power ¹⁾	P _{nom}	1800W	2000W
	P10minutes	2100W	2500W
	P _{surge}	4000W	5500W
Output voltage / frequency		230Vac ± 2% / 50Hz or 60Hz ± 0.05%	
Output waveform		True sinewave (THD < 5% ¹⁾ @ P _{nom})	
Input voltage :	Nominal	12Vdc	24Vdc
	Range	10.5 ²⁾ – 16Vdc	21 ²⁾ – 32Vdc
Maximum efficiency		92%	93%
No load power consumption ³⁾ [ASB]		<20W [3.5W]	<20W [4W]
Charger stage			
AC input voltage		185 - 270Vac / 45 - 65Hz / PF > 0.95	
Maximum continuous charging current ⁴⁾ (Secondary output)		80A (4A)	50A (4A)
Standard charge voltage (bulk / float @ 25°C)		14.3V / 13.3V (programmable)	28.6V / 26.6V (programmable)
Charge algorithm		IUoUoP, intelligent 4-stage, temperature compensated (programmable)	
AC Transfer switch			
Maximum continuous current		30Arms	
Transfer time (typical)		0ms (inverter → mains) / < 5ms (mains → inverter)	
General			
TBSLink enabled		Yes	
Protections		high/low battery voltage, high temperature, overload, short circuit, high ripple voltage and low AC input voltage	
DC connections		M10 bolt terminals	
AC connections		Screw terminals	
Enclosure body size (height x width x depth)		370 x 431 x 132mm	
Total weight		18.5 kg	
Protection class / operating temp. / storage temp.		IP21 / -20°C to + 50°C / -40°C to + 80°C (humidity max. 95% non condensing)	
Standards		CE marked meeting EMC directive 2004/108/EC and LVD 2006/95/EC complying with EN60335-1, EN60335-2-29 and RoHS 2002/95/EC	

Note: the given specifications are subject to change without notice.

¹⁾ Measured with resistive load at 25°C ambient. Power ratings are subject to a tolerance of 10% and are decreasing as temperature rises with a rate of approx. 1.2%/°C starting from 25°C.
²⁾ Undervoltage limit is dynamic. This limit decreases with increasing load to compensate the voltage drop across cables and connections.
³⁾ Measured at nominal input voltage and 25°C
⁴⁾ At high ambient temperatures, maximum output current shall be reduced automatically



Dimensions

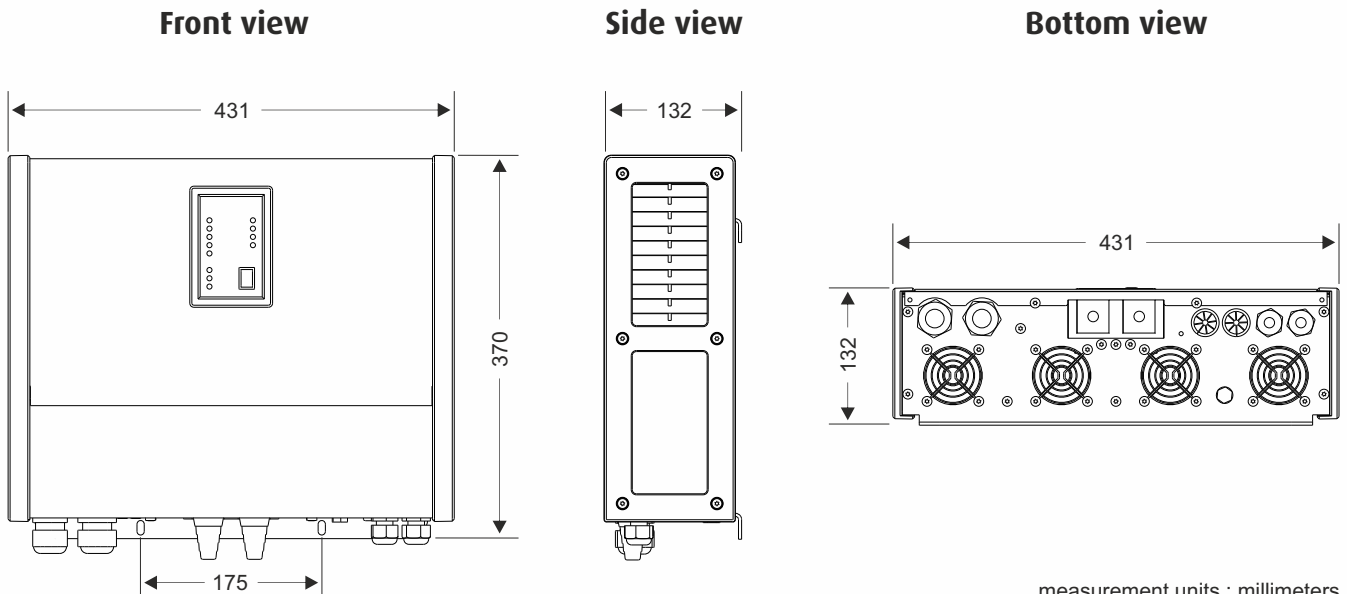

measurement units : millimeters